

# Longneck Bottle

## Bottle Dimensions

9" tall  
7.5" Diameter

### Max Label Dimensions:

7.5" around (full wrap) x 3.5" tall

Cut Line

1/8" Bleed

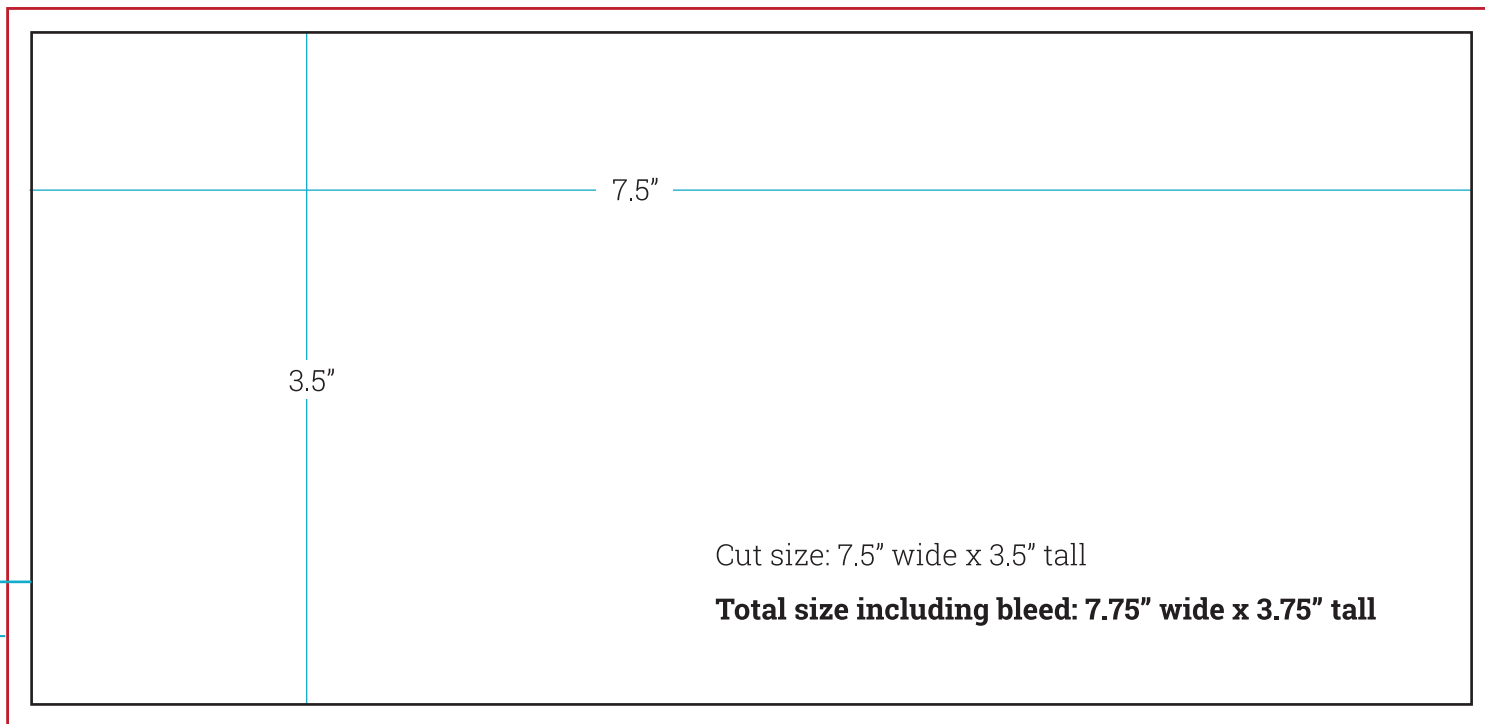

### Common Label Dimensions:

5" wide x 3.5" tall

## Custom Die Cut Labels Available.

Please provide the cut line and 1/8" bleed for custom die cuts. Examples:

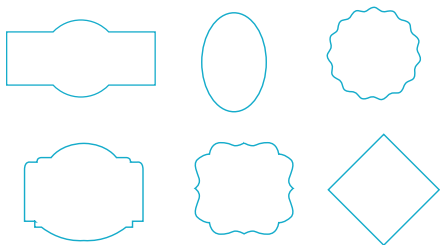

Cut Line

1/8" Bleed

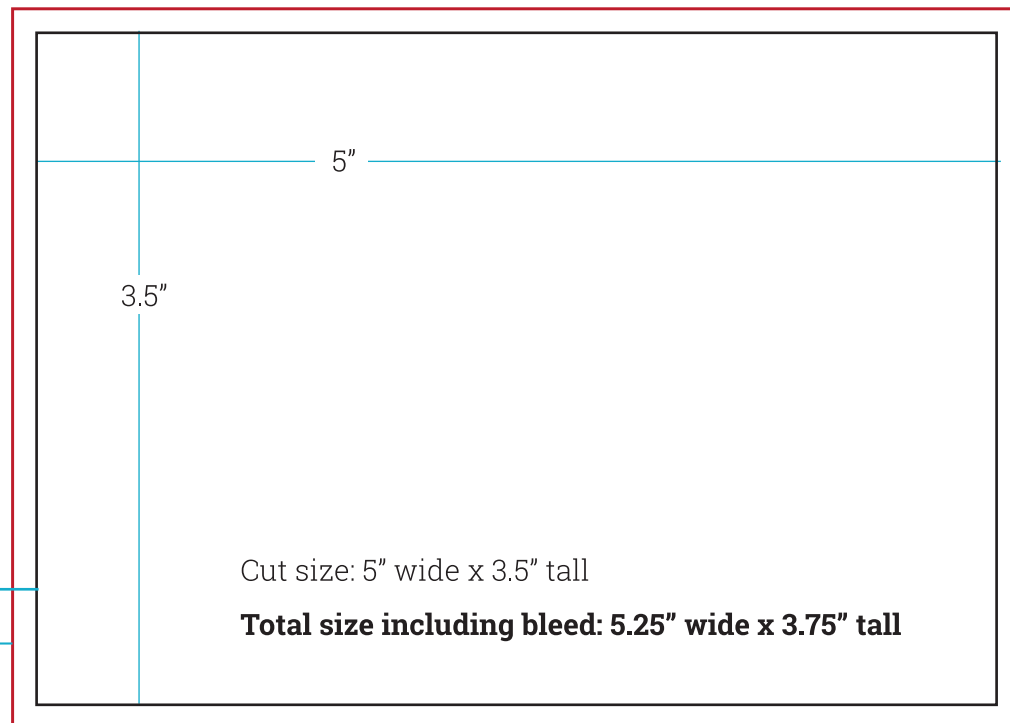

801.994.6490  
info@customsodalabels.com  
customsodalabels.com

# Stubby Bottle

## Bottle Dimensions

7.5" tall  
8" Diameter

## Max Label Dimensions:

8" around (full wrap) x 2.75" tall

Cut Line  
1/8" Bleed

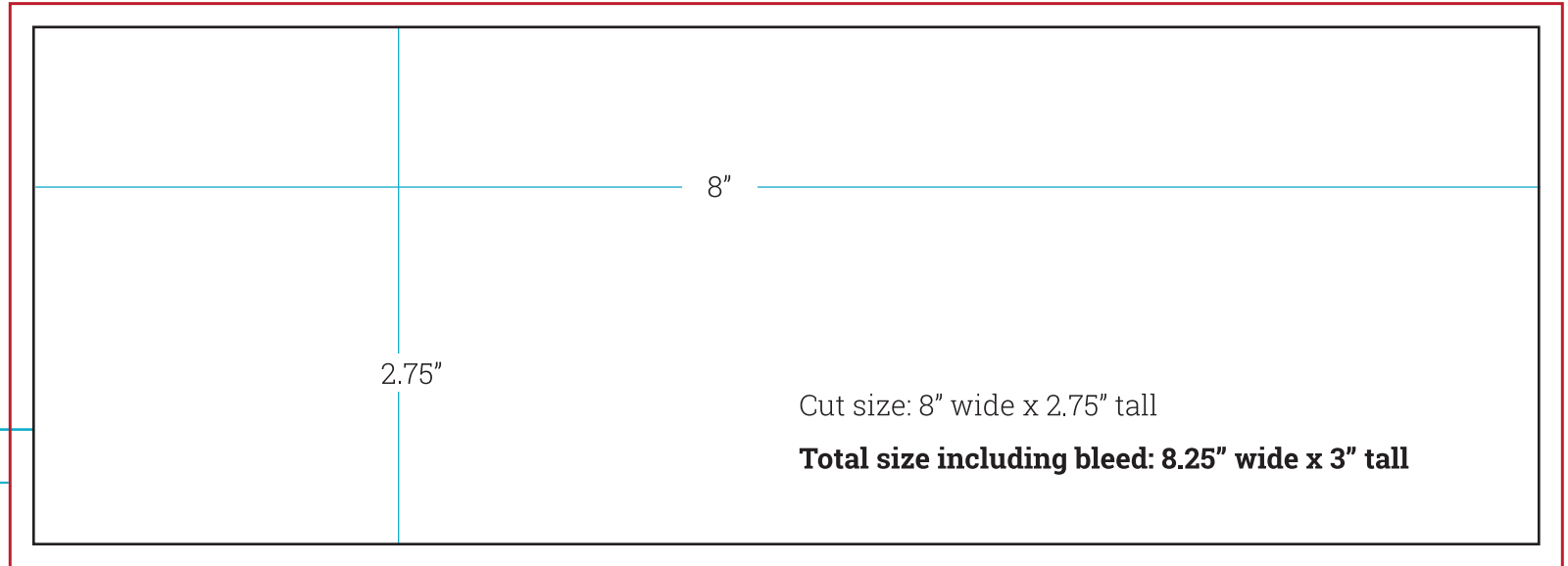

## File Types:

Adobe Illustrator, Print-quality PDF, EPS, High Resolution JPG or PNG (300 DPI please)

## Custom Die Cut Labels Available.

Please provide the cut line and 1/8" bleed for custom die cuts. Examples:

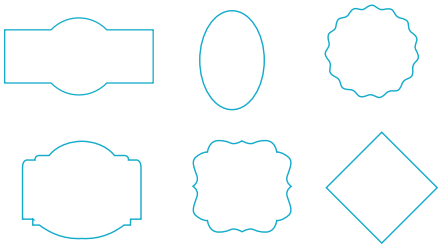

## Common Label Dimensions:

4.75" wide x 2.75" tall

Cut Line  
1/8" Bleed

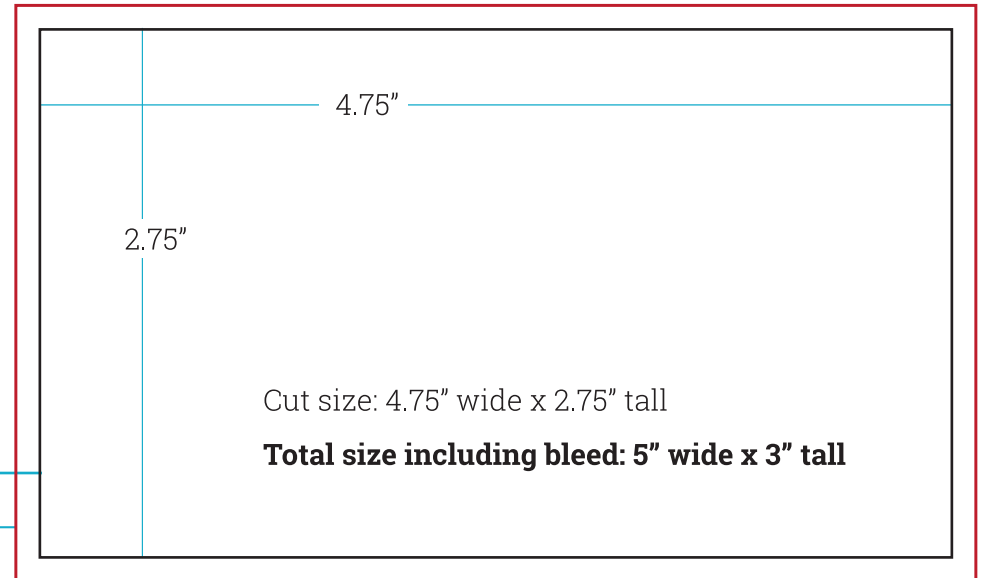

801.994.6490

info@customsodalabels.com  
customsodalabels.com

# Water Bottle

## Bullet Bottle Dimensions

9" tall  
7.5" Diameter

**Max Label Dimensions:**  
7.5" around (full wrap) x 5" tall

Cut Line

1/8" Bleed

## Custom Die Cut Labels Available.

Please provide the cut line and 1/8" bleed for custom die cuts. Examples:

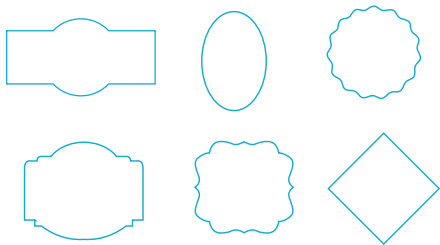

**Common Label Dimensions:**  
5" wide x 3.5" tall

Cut Line

1/8" Bleed

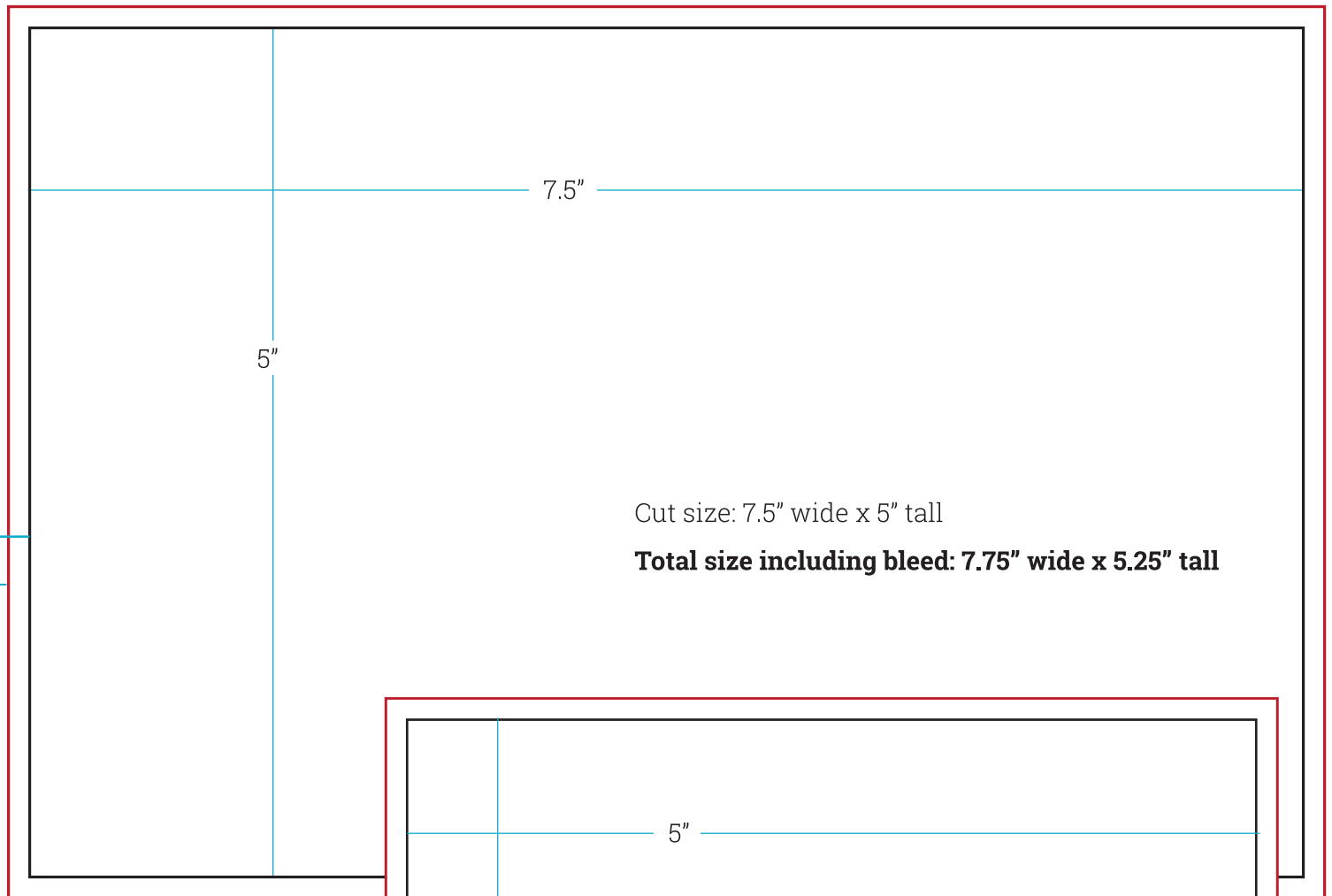

Cut size: 7.5" wide x 5" tall

**Total size including bleed: 7.75" wide x 5.25" tall**

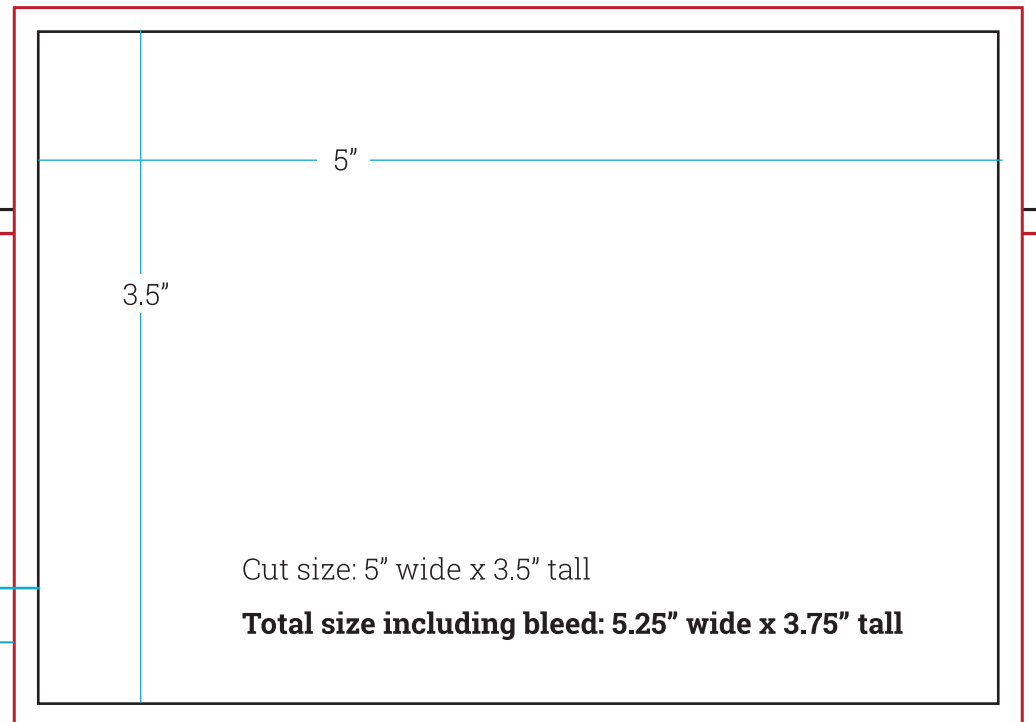

Cut size: 5" wide x 3.5" tall

**Total size including bleed: 5.25" wide x 3.75" tall**



**801.994.6490**  
info@customsodalabels.com  
customsodalabels.com